

HMS *Electronics*

5935 Labath Avenue, Rohnert Park, California 94928 Tel: (707)584-8760 Fax: (707)584-7052

Web Address: <http://www.hms-electronics.com>

Email: hmselect@sonic.net

HS3 Anode Rotator 'HIGH SPEED STARTER'

**"R VERSION"
or
"R/Q VERSION"**

INSTALLATION AND SERVICE MANUAL

Rev 4.00

CONTENTS

1. SAFETY & EMC DECLARATION	3
2. DIMENSIONS	4
3. INSTALLATION PLANNING DATA	4
4. INSTALLATION CONNECTIONS.....	5
4.1 POWER.....	5
4.1.1 440 VOLTS HIGH SPEED START VOLTAGE	6
4.1.2 500 VOLTS HIGH SPEED START VOLTAGE	6
4.1.3 LOW SPEED START , AC BRAKE VOLTAGE	6
4.2 VERIFY LIGHTS	6
4.3 INTERFACE INPUTS AND OUTPUTS	7
4.4 INPUT SPECIFICATIONS.....	7
4.5 STATOR CONNECTIONS	8
4.6 APPLY POWER	8
5. STATORS.....	9
5.1 STANDARD STATOR WIRING COLORS	9
5.2 TYPICAL STATOR RESISTANCE	9
5.3 STATOR VOLTAGES	10
5.4 SPECIAL STATORS.....	10
5.5 X-RAY TUBE CALIBRATION	11
6.0 'T1' INPUT MODE	11
6.1 MODE 0: T1 INPUT REQUIRED	11
6.2 MODE 1: T1 DEFAULT	11
7. SETUP (PROGRAMMING).....	12
7.1 STATOR TYPE	12
7.2 LOW SPEED BOOST TIME	13
7.3 DC BRAKE TEST, TIME	13
7.4 TEST-MEASUREMENT LOW SPEED.....	13
7.5 HIGH SPEED BOOST TIME	13
7.6 AC BRAKE TIME	13
7.7 TEST-MEASUREMENT HIGH SPEED	13
7.8 APPLICATION (RAD,RAD/FL,AUTO).....	13
7.9 'FL' COMMAND	13
7.10 FLUORO HANGOVER (HOLD) SECONDS.....	14
7.11 FLUORO HANGOVER (HOLD) MINUTES.....	14
7.12 HIGH SPEED HANGOVER (HOLD) SECONDS	14
7.13 HIGH SPEED HANGOVER (HOLD) MINUTES	14
7.14 EXPOSURE DELAY	14
7.15 'SF' COMMAND	14

7.16 'HS' COMMAND	14
7.17 'KAUX' PROGRAMMING	14
7.18 INTERLOCK PROGRAMMING	14
7.19 COAST COMMAND	15
7.20 COAST TIME	15
7.21 EXIT SETUP & SAVE TO EEPROM.....	15
8. HS3 DIAGNOSTICS	16
9. ERRORS (GENERAL)	20
9.1 SERVICE MODE (INTERFACE):	20
9.2 ERROR MESSAGES & EXPLANATION:.....	20
9.3 RESET DURING OPERATION	22
9.4 EEPROM ERRORS	22
9.5 WEB SITE, ADDITIONAL INFORMATION	22
10. TROUBLE SHOOTING (BOARDS).....	23
10.1 INVERTER/DRIVER (CB570):	23
10.2 POWER RELAY BOARD (CB513).....	23
10.3 TUBE SELECT & CURRENT BOARD (CB572)	24
10.4 INTERFACE & POWER SUPPLY (CB573)	24
10.5 MICROPROCESSOR BOARD (CB574).....	25
11. THEORY OF OPERATION (OVERVIEW).....	26
12. THEORY OF OPERATION (BOARDS)	27
12.1 INVERTER CB570	27
12.2 POWER RELAY BOARD CB513	27
12.3 TUBE SELECT & CURRENT CB572.....	27
12.4 INTERFACE BOARD CB573	28
12.5 PROCESSOR BOARD CB574	28
13.0 PARTS LISTS (MAIN)	29
13.1 HS3-R MASTER PARTS LIST	29
13.3 HS3-RQ MASTER PARTS LIST	30
14. SCHEMATICS.....	32

1. SAFETY & EMC DECLARATION

We, HMS Electronics
 5935 Labath Avenue
 Rohnert Park, Ca., 94928
 Phone:(707)584-8760
 Fax:(707)584-7052

declare under our sole responsibility that our products (for those models listed below) to which this declaration relates, are in conformity with the following directives:

EN60601-1 Medical Electrical Equipment- Part1:
General Requirements for Safety.

EN60601-1-2 Medical Electrical Equipment:
Collateral Standard:Electromagnetic Compatibility -Requirements & Tests

Model Numbers	Description
HS3-R	Anode Rotator (High Speed Starter)
HS3-RQ	Anode Rotator (High Speed Starter)
HS3S-RQ	Anode Rotator (High Speed Starter)

Richard D Harkey

SIGNATORY OF COMPANY
TITLE:CEO
LOCATION:5935 LABATH AVE
ROHNERT PARK, CA, 94928

We have received the following Underwriters Laboratory (U.L.) approvals
EN60601-1, UL2601-1 and CAN/CSA C22.2 No.606.1, Medical Devices File: E190636
and EMC File:E190636

Shipping & Storing: While packed for transport or storage, of being exposed for a period not exceeding 15 weeks to environmental conditions outside of the following ranges:

- a) an ambient temperature range of -40 degrees C to +70 degrees C;
- b) a relative humidity range of 10% to 100%, including condensations;
- c) an atmospheric pressure range 500 Hpa to 1060 Hpa.

2. DIMENSIONS

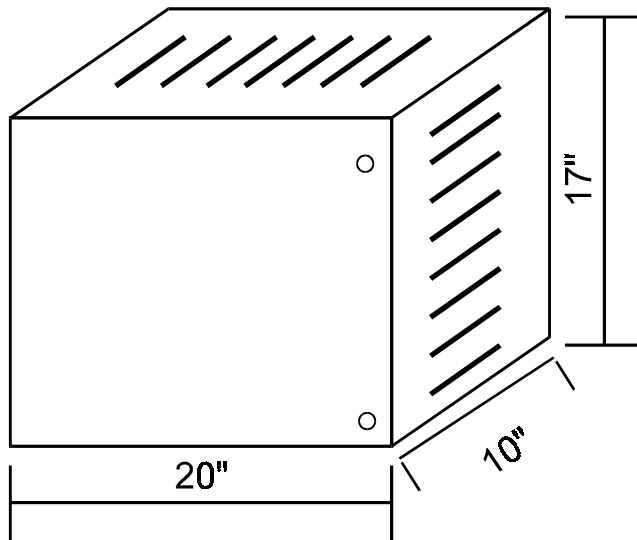

HS3 CABINET

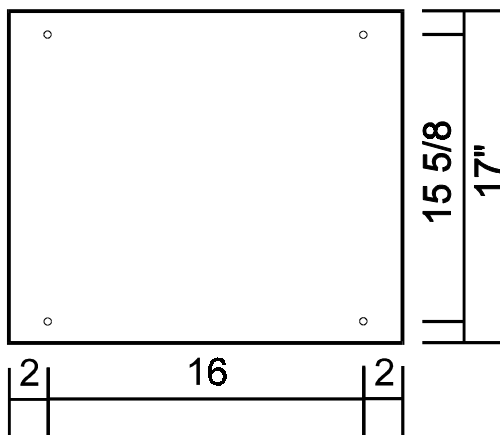

Enclosure Mounting
Hole pattern

3. INSTALLATION PLANNING DATA

The system consists of a standard 19 inch rack of electronics (approximately 41 pounds) mounted in a NEMA enclosure (25 pounds).

Power Requirements Model HS3-xx

208 to 240 VAC

50-60 Hz Single Phase

15 Amp "R" Version

30 Amp "R/Q" version

Suitable for use on a circuit capable of delivering not more than 5,000 RMS Symmetrical Amperes, 240 volts maximum.

Power Requirements Model HS3-xx-277

208 to 277 VAC

50-60 Hz Single Phase

15 Amp "R" Version

30 Amp "R/Q" Version

Suitable for use on a circuit capable of delivering not more than 5,000 RMS Symmetrical Amperes, 277 volts maximum.

Mounting:

NEMA Type I enclosure

Total weight 70 pounds.

NOTE: The "R/Q" unit requires branch circuit protection with maximum 30 Amp protector. The "R" unit requires branch circuit protection with a maximum 20 Amp protector. It is recommended that a multiconductor cable be used for interface connections. The interface wiring or cable must have a 600 Volt insulation. Recommended wire size for interface 20 Gauge maximum.

The proper sequence of installation steps are as follows.

1. Measure the line voltages and connect

low voltage transformer and autotransformer taps.

2. Connect Mains
3. Turn on power and verify display and lights OK.
4. Connect inputs and outputs.
5. Connect stators.
6. 'SETUP' (program functions)

The proper manner to perform these steps is explained in the following pages.

4. INSTALLATION CONNECTIONS

4.1 Power

NOTE: It is recommended that the line matching be done prior to mounting the unit into the cabinet. Connection of the mains may be done before or after mounting the chassis, at the discretion of the installer.

MAINS-Using supplied wiring: Use maximum 10 Gauge wire or minimum 14 gauge wire for the "R" or "R/Q" models.

Wiring is provided for easy connection of mains by using wire nuts (provided) for splicing of the mains to the starter. If a neutral is provided, connect the neutral to the blue 14 gauge wire. Connect the hot leg to the black wire. If no neutral is provided, connect the mains to the blue and black wires.

Ground: Attach the power mains ground to the cabinet which is used for mounting the starter. Ground the chassis by connecting a wire (16 gauge minimum) from the ground stud of the starter chassis to the mains ground point in the cabinet. The ground stud location (looking from the rear) is the left side panel of the starter chassis four inches from the bottom. A grounding wire is provided for this connection.

MAINS-Customer supplied wiring

The incoming line may be connected directly to the circuit breaker which is mounted to the front of the chassis. Sufficient wire length is

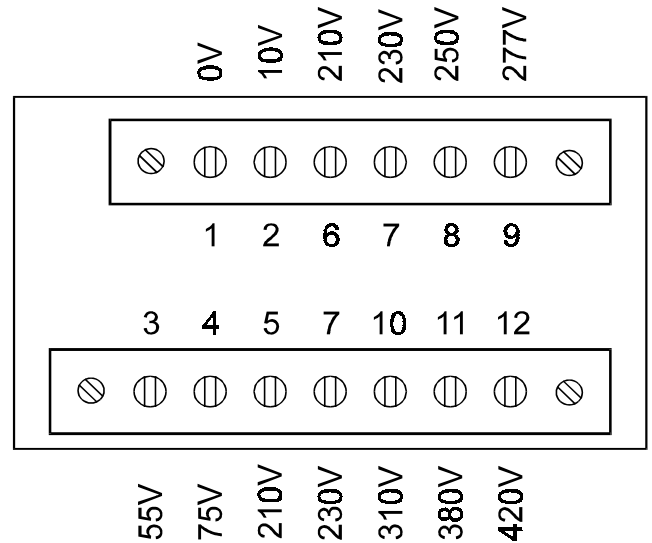

6331 AUTO TRANSFORMER

- I.E. If the incoming line is 220 volts;
1. Move the black wire (L1) to terminal 7 (230 volts).
 2. Move the blue wire with black trace (L2) to terminal 2 (10 volts).

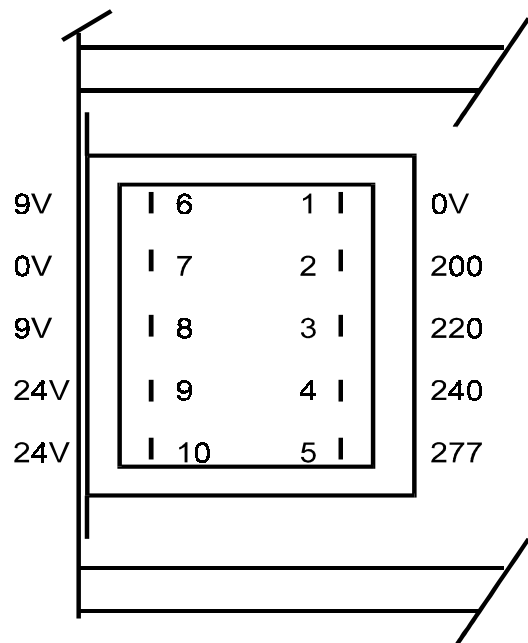

Low Voltage Transformer #6165 Connections (View from rear)

provided in order to remove the circuit breaker assembly for attaching of the mains. If a 220 volt wire and neutral wire are provided, connect the neutral to the blue wire side of the circuit breaker and the 220 volt leg to the black wire side of the circuit breaker. Connect the ground wire to the #8 stud provided at the left rear of the chassis. Strain relief the incoming wires by using the wire tie and loop holes as provided next to the ground stud.

Line Matching:

Measure the incoming line voltage leg to leg. Select the proper line matching taps on top of 1T1 (autotransformer) & 1T2 (low voltage transformer). The autotransformer taps are accessible by tipping the 19 inch rack assembly down (if the chassis is installed into the HS3 cabinet). The low voltage transformer line matching taps are available only at the rear of the chassis. 1T2 is located behind the circuit breaker panel.

10 VOLT Tap.

If 'Q' stators are used exclusively, move the blue wire on the autotransformer from terminal 1 to terminal 2 (the 10 volt tap). This will reduce the run voltage to optimum for reduced heat into the tube housing.

Once the taps are connected, turn on power and measure for one of the following:

4.1.1 440 Volts High Speed Start Voltage

Measure the 380 volts from terminals 1 to 11 on the autotransformer. If this voltage is greater than 390 VAC change the input taps to provide a lower output. Under no condition may the autotransformer output voltage be greater than 390 VAC from tap 1 to 11 (380 Volt tap). The 10 volt tap is intended for fine adjustment of the line input. The high speed start voltage wire is red with a black stripe.

4.1.2 500 Volts High Speed Start Voltage

Measure the 420 volts from tap 1 to 12 on the autotransformer. If this voltage is greater than 430 VAC change the input taps to provide a lower output. Under no condition may the autotransformer output voltage be greater than 430 VAC from tap 1 to 12 (420 Volt tap). The 10 Volt tap is intended for fine adjustment of the line input. The high speed start wire is red with a black stripe and is shipped from the factory attached to terminal 12 of the autotransformer for 500 volts start voltage.

4.1.3 Low Speed Start , AC Brake Voltage

Low speed start voltage (also the AC brake voltage) is factory selected at 230 Volts. Some European stators may require a different voltage. If greater voltage is required, move the red wire from terminal 7 (the 230 Volt tap) as follows:

Terminal	Voltage
7	230
8	250
9	277

(see the autotransformer drawing). Do not exceed 277 volts as this will exceed the voltage rating of the low speed phase shift capacitor.

4.2 Verify Lights

When power is applied, the following events occur:

1. The display is initialized
2. A diagnostic is performed on the RAM
3. A checksum is performed on the EPROM
4. The #9 LED of the processor light bar should be flashing at 1 Hz rate (if not in service mode).
5. The LED on the Inverter/Driver board (CB570) should be lit.

If all are OK, proceed with the installation connections.

K_{AUX} relay is under program control and is intended to be interfaced so as to provide separate low speed and high speed interlock signals to the generator. This is easily accomplished by connecting one leg of the current interlock (Ka-Kp [CB511]) to the common of Kaux and then the low speed interlock connected to the normally closed contact. The high speed interlock would of course be wired to the normally open contact.

4.3 Interface Inputs and Outputs

All generator logic inputs and outputs are made to the J1 connector on the front edge of the interface board (CB573).

The interface outputs of this starter are all relay contacts. They will carry a maximum 3 amps at 30 VDC or 250 VAC.

All inputs go into optocouplers. The standard manner of making a command is to apply 5, 12 or 24 Volts DC to the input optocoupler.

CB573LV interface board is a low voltage DC interface for input commands from the generator. Three resistor values are specified for the most common input voltages and are supplied with the starter along with the 16 pin screw terminal plug for interface connections. The input resistors are SIP resistor packs plugged into sockets for easy changing.

Pull-down connections (Rev 1 Boards):

Connect external voltage source to the V+ terminal. Insert jumpers on connections 2-3 and 4-5 on CB573LV. Connect appropriate inputs to the pull-down source.

Pull-up connections (Rev 1 Boards):

Connect generator external common to the 0 volt terminal. Insert jumpers on connections 1-2 and 3-4 on CB573LV. Connect appropriate pull-up inputs to the external pull-up source.

Rev 2 Boards do not have jumpers and are used with **pull-down** interface drives only.

Note: CB573LV does not supply any voltage for interfacing as this would defeat the purpose of the optocouplers. If a variety of inputs are used, the input SIP resistor packs can be replaced with individual 1/4 watt resistors; i.e.. +24 volt for tube selection and +5 volt for 'ST' would require separate value resistors.

Other interface boards may be supplied at the customers request. Interfacing information for a special board will be supplied with that board.

Input Commands:

ST = Start rotation (PREP)

FL = Fluoro (see 'FL Command' in setup for function)

HS = High Speed (see 'HS Command' in 'Setup' for function)

SF = Spot Film / Spot Film Camera (see 'SF Command' in 'Setup' for function)

CO = Coast

T3 = Tube 3 Selection

T2 = Tube 2 Selection

T1 = Tube 1 Selection

4.4 Input Specifications

Input Voltage	Input Resistors (RP1)
22-26 VDC	3.3K .2W
10-15 VDC	1.0K .125W
4-6 VDC	270 .125W

Typical input current for the optoisolators is 6 milliamperes minimum, and 20 milliamperes maximum.

4.5 Stator Connections

Screw terminal connectors for the stator connections are provided with the starter. Connect the stator wires to the connectors as follows:

- 1=White (**C**ommon)
- 2=Black (**P**rinciple)
- 3=Red or Green (**A**uxiliary or shifted)

Connect the stator shield to the chassis ground. Connect the tube housing ground wire (if provided) to the high tension transformer ground.

Note: the wire colors should match the 'Standard Stator Wiring'. See diagram to the right.

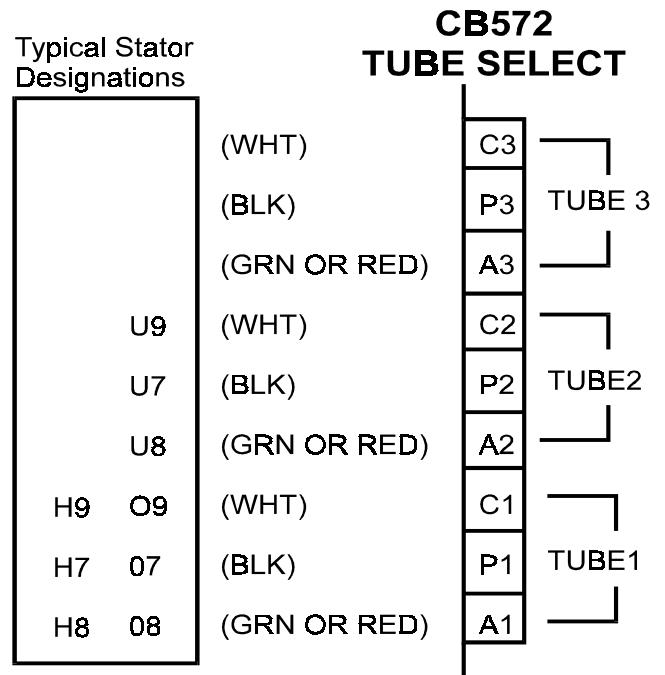

Please note:

Any **Green** wire with a yellow stripe is not a stator power wire but a ground wire!

4.6 Apply Power

When power is applied, the processor board does a self test. During a normal start-up sequence the message 'Testing Board Integrity' is displayed for a very short time. Four tests are performed during start-up. They are as follows:

Testing Board Integrity 1: Test 1 is a RAM test. If the RAM (memory) fails, a message is displayed.

Testing Board Integrity 12: Test 2 is zeroing of the RAM.

Testing Board Integrity 123: The Eprom checksum is tested to verify the Eprom is good. If the Eprom checksum fails, a message is displayed

Testing Board Integrity 1234: The program is waiting for a line interrupt (zero line cross

from the interface board). If the zero line cross is not present, this message will stay on the display. If all the above passes and a Tube Selection is made, on a new installation the display should read 'Begin Setup Now, Press Test'. Refer to the Setup instructions. If the starter has already been setup, it will display the version of the software, and a 'Ready' message.

If no 'Tube Selection' has been made, the display will read 'Waiting Tube Selection'.

5. STATORS

On the edge of the tube selection board (CB572) are three terminal blocks for the stator connections. Typical stator wire identification is as follows:

5.1 Standard Stator Wiring Colors

CB572 Color

- P = Black**
(Principal Winding or Main)
- A = Green or Red**
(Auxiliary or Phase Shifted)
- C = White**
(Common Winding)

5.2 Typical Stator Resistance

'R' Stator Resistance

- C-P (White to Black) 15-20 Ohms
- P-A (Black to Green or Red) 45-70 Ohms
- C-A (White to Green or Red) 30-50 Ohms

'Q' Stator Resistance

- C-P (White to Black) 7 Ohms
- P-A (Black to Green or Red) 19 Ohms
- C-A (White to Green or Red) 12 Ohms

'Balanced' Stator Resistance (G.E)

- C-P (White to Black) 25 Ohms
 - C-A (White to Green or Red) 25 Ohms
 - P-A (Black to Green or Red) 50 Ohm
- Note: 'High Speed' Phase-Shift-Capacitor Change Required.

'E' Stator Resistance (Philips)

Wired for 'Rapid Start'

- C-P (White to Black) 11 Ohms
 - P-A (Black to Green or Red) 25 Ohms
 - C-A (White to Green or Red) 13 Ohms
- Note: 'High Speed' Phase-Shift-Capacitor Change Required.

5.3 STATOR VOLTAGES

The following voltages (+-10%) should be the typical output voltages of the starter as measured Common to Principle (C-P).

	<u>START</u>	<u>RUN</u>	<u>BRAKE</u>
Q STATOR	350 VAC 180 HZ	60 VAC 180 HZ	220 VAC BRAKE 1, 50 VDC BRAKE 2
Q STATOR	220 VAC 60 HZ	52 VAC 60 HZ	50 VDC BRAKE
R STATOR	440 VAC 180 HZ	100 VAC 180 HZ	220 VAC BRAKE 1, 60 VDC BRAKE 2
R STATOR	220 VAC 60 HZ	54 VAC 60 HZ	60 VDC BRAKE

*With tap 12 on the autotransformer selected:

R STATOR ~500 VAC 180 HZ 100 VAC 180 HZ 220 VAC BRAKE 1, 60 VDC BRAKE 2

5.4 Special STATORS

G.E. (Balanced Stator)

The optimum high speed phase shift capacitor is 12-15 microfarad. The tube will spin up about 150% faster with the correct capacitor installed.

'RQ models' with 'R' and 'GE' Stators This procedure allows for optimum operation of an 'R' stator and a G.E. balanced stator. Replace capacitor '1C2a' (15 microfarad) with a 6 microfarad. Select 'Q' type stator in 'SETUP' mode. With the 'Kr-q' relay selected, the capacitors '1C2' and '1C2A' are put in parallel. This provides the 12 microfarad phase shift capacitance needed for the GE stator. Move the 'Q' start voltage wire (red with a white stripe) from terminal 10 (310 volts) of the autotransformer to terminal 11 (380 volts) or terminal 12 (420 volts). Change R4 on CB572 from 20k to 47k (the 'main' or 'Principle' current is very low in high speed and requires an increase in gain). It will be necessary to perform the 'Setup-Test Rotations' in service mode.

'RQ models' with 'GE' and 'Q' Stators This procedure allows for optimum operation of a 'GE' stator and a 'Q' stator. Replace capacitor '1C2' (6 microfarad) with a 15 microfarad (660 VAC). Replace '1C2a' (a 15 microfarad 440 VAC capacitor) with the 6 microfarad removed in the preceding step. Select 'R' type stator in 'SETUP' mode. Change R4 on CB572 from 20k to 33k (the 'main' or 'Principle' current is very low in high speed and requires an increase in gain). If the 'P' safety is intermittent, reduce the value of R16 (510 ohm) on CB572 to 330 ohms. This will allow for lower currents to trigger the current detection circuit. It will be necessary to perform the 'Setup-Test Rotations' in service mode.

'R models' Replace capacitor '1C2' (6 microfarad) with a 12-15 microfarad (600 VAC) for or parallel '1C2' with another 6-8 microfarad capacitor (600 VAC). Select 'R' Balanced type stator in 'SETUP' mode. Note: Changing the phase shift capacitor for the G.E. tube will make the starter incompatible with an 'R' tube. Change R4 on CB572 from 20k to 47k (the 'main' or 'Principle' current is very low in high speed and requires an increase in gain). It will be necessary to perform the 'Setup-Test Rotations' in service mode.

Philips (Rapid Start Configuration) 'RQ' models only

The stator must be configured as 'rapid start' or low impedance mode. To configure the stator (tube housing) for 'rapid start' the stator windings are wired in parallel instead of in series. The phase shift capacitance required for high speed is 12 microfarad. Therefore, capacitor '1C2A' needs to be changed from 15 microfarad to 6 microfarad. With 'Kr-q' relay on, the capacitors '1C2' and '1C2A' are put in parallel. This provides the 12 microfarad phase shift capacitance needed for the Philips stator. Select 'Q' Philips stator in 'SETUP' mode. Move the 'Q' start voltage wire (red with a white stripe) from terminal 10 (310 volts) of the autotransformer to terminal 7 (230 volts).

Note: it is not possible to connect a Philips 'Q' and a standard 'Q' (using this method) as they require different phase shift capacitors and start voltages.

Other Configurations: It is possible to wire the 'RQ' model to handle a variety of configurations, such as a 'Q' and a Philips or a GE and a Philips. Consult the factory for special configuration requirements.

5.5 X-ray Tube Calibration

Typically, during X-ray tube calibration, many rotation commands are issued to the starter which results in a large heat build up in the tube housing. In order to reduce heat into the X-ray tube during calibration, the following is recommended:

1. Temporarily program that tube 'Application' for RAD/FL (always hold or continuance).
2. Set the minutes for low speed hold to a minimum of 1.
3. Set the minutes for high speed hold to a minimum of 1.

After Calibration of the X-ray tube, return these three temporary settings to their original settings.

6.0 'T1' INPUT MODE

T1 input (Tube 1 selection) is programmable as to use or function. It can be set for 'normal operation' (Mode 0) in which the T1 input must be active to select tube 1. Or, it can be set to mode 1 which means that the T1 input signal is not required for Tube 1 selection.

To enter 'T1 Input Mode' programming press and hold both the 'Value+' key and the 'Step-' key while turning on the power (use the local circuit breaker).

The message on the display will be 'T1 Input Mode' and the second line of the display will indicate the current mode as show below for modes 0 and 1.

To toggle the mode, use the value -/+ keys. The display will reflect the mode setting or change. To exit and save the changes, press the Setup/Test Switch on the keypad.

6.1 Mode 0: T1 input Required

Mode 0 means that the T1 select input must be active to select tube 1. With no Tube selections enabled, the message 'Waiting Tube Selection' will appear on the display.

6.2 Mode 1: T1 default

Mode 1 means that the starter defaults to tube 1 selection (no tube selection required for tube 1). Use the T2 and T3 inputs to select tube 2 and tube 3 as needed.

7. SETUP (PROGRAMMING)

SETUP or programming of the starter is accomplished by entering 'SETUP' mode. Each step of the programming mode is mostly self explanatory. However, each programming step is detailed on the following pages to clarify their usage. Each tube is independently programmed. The values, along with a checksum, are saved to the EEPROM at the 'Exit' step of the program. The checksum is used upon tube selection to validate the 'SETUP' values. If the checksum does not match, an error message will be generated and the tube in question will have to be reprogrammed.

The 'TEST' button is used to rotate the tube for low speed and high speed test & measurements. This allows for easy checking of the 'SETUP' values and for servicing.

To enter 'SETUP' press the 'TEST' button on the keypad (a tube must be selected and the ready message must be present).

Note: a convenient header on the Interface board is provided so that all input selections can be attained by inserting a shorting bar across the appropriate terminals. I.E. Use the Service jumper and insert for tube 1 selection in order to program tube 1 without interface connections or connector in place.

IMPORTANT: The 'Test-Measurement' rotation modes measure the currents of the stator windings and saves the adjusted values to memory. If the stator is too hot, then the measured values will be slightly low due to the increased resistance of the stator. Then when the tube cools down, the measured currents could exceed the expected maximum value. Therefore, it is recommended that the test rotations be done on a cool or moderately warm stator.

IMPORTANT: A minimum DC brake time is calculated for the test rotations (3 times the low speed boost time). This time will be used if longer than the programmed time. Specifically, the anode must be accelerated from a dead stop during 'Setup'.

Note: The shifted or 'A' current rises as the motor (anode) approaches resonance with the applied frequency. Always provide enough accelerate time to allow the stator to attain full speed. After the test rotations have been completed, the DC brake and accelerate times can be adjusted to best suit the installation requirements. The feedback voltage on R22 of CB572 will reflect the rise in voltage as the motor approaches resonance. You can set a long accelerate time, and then monitor this voltage to determine the minimum accelerate time for the motor.

When reprogramming the starter ('Setup'), only values that are changed are recorded in the EEPROM. So the test rotations can be skipped when reprogramming the various options and delays.

7.1 Stator type

'R' Regular 20/50 ohm

'R' Balanced 25/25 ohm

'R' S type 15/30 ohm

'R' type (High Gain) use this selection for any of the above type stators when the gain of the 'P' measurement circuit has been increased. (See Note1)

'Q' Low Z 7/12 ohm

'Q' (Philips 'RS') 11/15 ohm..... (requires a change in phase shift capacitor and voltage tap changes)

'None' (Disabled) all of the rest of the 'SETUP' steps are skipped and 'EXIT 'SETUP' is selected.

Note1: When utilizing an NAI (North American Imaging) housing, the current on the main winding is so low that the measurement circuit has to be modified. See section 9.2.7 to effect the change. After increasing the gain of the measurement circuit and a second 'R', Balanced or RS stator is used, select Hi-Gain for this stator.

Example1: Tube 1 is an NAI housing, Tube 2 is an 'R' stator. Increase the gain of the 'P' measurement circuit, select 'R' stator for tube 1 and Select Hi-Gain for tube 2.

Example2: Tube 2 is an NAI housing, Tube 1 is an 'R' or 'S' or Balanced stator. Increase the gain of the 'P' measurement circuit, select Hi-Gain for tube 1 and 'R' (Regular) for tube 2.

Note2: If you wish to exit 'Setup' without saving the values, press the 'test/exit' button at this time. This feature was added in case 'Setup' was entered accidentally.

7.2 Low Speed Boost Time

.8 to 9.9 Seconds (.1 second increments)

7.3 DC Brake Test, Time

0 to 9.9 Seconds (.1 second increments)

The 'Test' button may be used to verify the DC Brake setting in order to obtain the boost/brake combination as desired.

7.4 Test-Measurement Low Speed

Press and hold the 'Test' button on the Starter for at least 2 seconds after the boost cycle has completed. The start (boost) and run currents are measured and saved to memory. Hold for sufficient time to stabilize the measurement. If the service jumper on the interface board is in the normal position, the measured values are compared to a table of values appropriate to the stator type programmed. If the measured values fall outside the normal range, a 'range measurement' error message will be displayed. The values obtained during **acceleration** and **run** are adjusted to minimum and maximum values and saved to memory.

Service Mode: In 'Service' mode the lookup tables will not be used to 'verify' that the measurements fall within an expected range of values. Use the 'Service' mode to complete 'Setup' when the stator and applied voltages are known to be good. The interlock is disabled while in service mode. Complete the 'Setup' procedure before returning to 'Normal' operation (finish the test rotations in 'Service' mode and program the measured values into the EEPROM).

7.5 High Speed Boost Time

.8 to 19.9 Seconds (.1 second increments)

7.6 AC Brake Time

.8 to 9.9 Seconds (.1 second increments)

7.7 Test-Measurement High Speed

Press and hold the 'Test' button on the Starter for at least 2 seconds after the boost cycle has completed. The start (boost) and run currents are measured and saved to memory. Hold for sufficient time to stabilize the measurement. If the service jumper on the interface board is in the normal position, the measured values are compared to a table of values appropriate to the stator type programmed. If the measured values fall outside the normal range, a 'range measurement' error message will be displayed. The values obtained during **acceleration** and **run** are adjusted to minimum and maximum values and saved to memory.

Service Mode: In 'Service' mode the lookup tables will not be used to 'verify' that the measurements fall within an expected range of values. Use the 'Service' mode to complete 'Setup' when the stator and applied voltages are known to be good. The interlock is disabled while in service mode. Complete the 'Setup' procedure before returning to 'Normal' operation (finish the test rotations in 'Service' mode and program the measured values into the EEPROM).

7.8 Application (RAD,RAD/FL,AUTO)

RAD All hold (hangover or continuance) functions are disabled. All Fluoro and Spot Film commands/functions are skipped)

RAD/FL Always hold (hangover or continuance) for the programmed time. (This is for both high and low speeds).

AUTO DETECT Hold (hangover or continuance) is enabled if 'FL' or 'SF' commanded.

7.9 'FL' Command

LOW SPEED Rotation is initiated
HIGH SPEED Rotation is initiated
ENABLES HOLD No rotation is initiated

Note: Kaux relay is not turned on if 'FL' is programmed for high speed. This keeps compatibility with machines which require low speed interlock for Fluoro.

7.10 Fluoro Hangover (hold) Seconds

0-59 Seconds (1 second increments)

7.11 Fluoro Hangover (hold) Minutes

0-59 Minutes (1 minute increments)

Note: 0 minutes and 0 seconds cancels low speed hold.

7.12 High Speed Hangover (hold) Seconds

0-59 Seconds (1 second increments)

7.13 High Speed Hangover (hold) Minutes

0-59 Minutes (1 minute increments)

Note: 0 minutes and 0 seconds cancels high speed hold.

7.14 Exposure Delay

0-9.9 Seconds (.1 second increments)

While in a hold cycle (hangover or continuance), release and reapplication of a rotation command removes the Exposure Interlock for the duration of the programmed delay time. This feature is most often used when a 'spot film camera' is utilized which generally does not allow for enough time for the filaments of the x-ray tube to preheat.

7.15 'SF' Command

LOW SPEED Rotation is initiated

HIGH SPEED Rotation is initiated
ENABLES HOLD No rotation is initiated

7.16 'HS' Command

HIGH SELECT Requires 'ST' for rotation
HIGH SPEED Rotation is initiated
NOT ENABLED No High Speed Rotation

7.17 'Kaux' Programming

ON w/ROTATION The relay is on while the tube is being rotated and during brake. Useful for a tube change inhibit signal to the generator.

ON w/BRAKE Useful for a tube change inhibit signal to generator.

ON w/HIGH SPEED Rotation command.
Note: not on with high speed Fluoro

7.18 Interlock Programming

ON w/AC BRAKE Interlock will be removed if a High Speed Start is applied. This allows the interlock to remain closed during deceleration from high speed to low speed in order to maintain the Fluoro interlock.

OFF w/AC BRAKE Interlock is lost during AC brake period. The starter will not drop out of high speed hold/hangover while 'FL' is applied in order to maintain interlock during Fluoro.

On LH, ON AC BRKE The interlock will remain on when shifting from low speed to high speed (low to high). The interlock will also remain on while the AC brake is applied to shift from high speed to low speed. Maintaining interlock is useful if a large x-ray tube is utilized and exposure factors permit x-rays before the tube has obtained high speed. This way there is minimum exposure delay when fluoro is low speed and a high speed exposure request is made.

ON LH, Off AC BRK The interlock will

remain on when shifting from low speed to high speed (low to high). The interlock will turn off while shifting from high speed to low speed (during AC brake). Maintaining interlock is useful if a large x-ray tube is utilized and exposure factors permit x-rays before the tube has obtained high speed. This way there is minimum exposure delay when fluoro is low speed and a high speed exposure request is made.

7.19 Coast Command

DISABLED

ENABLED

The 'CO' (coast input) on the interface keeps the x-ray interlock on but removes any run voltage. This is useful for Digital applications to reduce any interference from the starter during acquisition of images.

Note: Rotation Command must be present for this command to be accepted. The 'Coast' command will not be accepted while in hold.

7.20 Coast Time

0 to 99 Seconds (1 second increments) If this time is exceeded, the starter will go into fault mode and exposures will be prevented.

7.21 Exit SETUP & Save to EEPROM

PRESS VALUE + Key to exit and save values to EEPROM.

Note: To exit setup without save to EEPROM refer to step 1 (stator type).

Note: On rare occasion the EEPROM may need to be restored to default (factory) values. Refer to section 9.4.

8. HS3 DIAGNOSTICS

These diagnostics allow the service engineer to check out and evaluate the interaction of the processor board and interface board as well as checking all processor board inputs and outputs.

The service jumper on the interface board plays an important role during the diagnostic mode. If the service jumper is in the normal position, the solid state relay is left off during all relay selections. Conversely, if the service jumper is in, then the solid state relay will turn on after the relays have been turned on. Please note that the state of the service jumper is only checked as the diagnostic is selected. Therefore, changing the jumper position while in a particular diagnostic will have no effect until the diagnostic is changed.

Whatever tube was selected when entering into the diagnostic mode is preserved during diagnostics.

Entering Diagnostic Mode:

With the ready message on the display, press any of the diagnostic switches on the keypad (Value-, Value+, Step-, Step+).

Diagnostic 1: MUX 'A' Low Gain

Sets low gain on the analogue MUX (CB572 U3) and addresses the 'A' (auxiliary) feedback. The feedback voltage is fed to the Analogue to Digital Converter (ADC) on the processor board and the measured value is displayed. Test voltages are provided on the board for servicing the feedback circuits. Jumper TP+ to TP2 to inject a positive voltage into the 'A' current measurement circuit. Jumper TP- to TP2 to inject a negative voltage into the 'A' current measurement circuit. The typical ADC result is 0 to 3 with no jumper. The typical ADC result

with a jumper connected is 45 to 55 decimal.

Note: The inverting and non-inverting circuits provide slightly different results (+-6).

Diagnostic 2: Mux 'A' High Gain

Same as diagnostic 1 except that high gain is selected on the analogue MUX (CB572 U3). The typical ADC result is 0 to 8 with no jumper. The typical result with a jumper inserted is 170 to 198 decimal.

Note: The inverting and non-inverting circuits provide slightly different results (+-6).

Diagnostic 3: Mux 'P' Low Gain

Sets low gain on the analogue MUX (CB572 U3) and addresses the 'P' (Principle) feedback. The feedback voltage is fed to the ADC on the processor board and is displayed. Test voltages are provided on the board. Jumper TP+ to TP1 to inject a positive voltage into the 'P' current measurement circuit. Jumper TP- to TP1 to inject a negative voltage into the 'P' current measurement circuit. The typical ADC result is 0 to 4 with no jumper. The typical ADC result with a jumper inserted is 25 to 35 decimal.

Note: The inverting and non-inverting circuits provide slightly different results (+-3).

Diagnostic 4: Mux 'P' High Gain

Same as diagnostic 3 except that high gain is selected on the analogue MUX (CB572 U3). The typical ADC result is 0 to 8 with no jumper. The typical ADC result with a jumper inserted is 150 to 165 decimal.

Note: The inverting and non-inverting circuits provide slightly different results (+-6).

Diagnostic 5: Display Port A

Displays a binary pattern representing the status of Port A (MSB-LSB). Port A bit assignments are as follows:

PA7	Output	K _{aux}
PA6	Output	K _{Interlock}
PA5	Output	SE2
PA4	Input	Service
PA3	Output	SE1
PA2	Input	'P' Safety
PA1	Input	'A' Safety
PA0	Output	Coast Pulses

Grounding the input pins, should cause these bits to go low. The normal binary representation should be: %11110110.

I.E.

- PA7 is high (K_{aux} not enabled)
- PA6 is high (K_{Interlock} not enabled)
- PA5 is high (U3 not enabled)
- PA4 is high (dependent on service jumper)
- PA3 is low (SE1 clear to U4 on CB573)
- PA2 is high ('P' Safety not low)
- PA1 is high ('A' Safety not low)
- PA0 is low (not coast pulses from CB574)

Diagnostic 6: Display Port B

Displays a binary pattern representing the status of Port B (MSB-LSB). Optocoupler outputs are input to Port B. Port B bit assignments are as follows:

PB7	Input	ST (Start)
PB6	Input	FL (Fluoro)
PB5	Input	HS (High Speed)
PB4	Input	SF (Spot Film)
PB3	Input	CO (Coast)
PB2	Input	T3 (Tube 3)
PB1	Input	T2 (Tube 2)
PB0	Input	T1 (Tube 1)

The normal binary pattern with the interface connector removed should be: %11111111. With the connector installed, then any active input will be represented by a low output. I.E. if Tube 1 is selected (T1) then bit 0 will be low (a zero) and the binary pattern would be %11111110.

Diagnostic 7: Display Port C

Displays a binary pattern representing the status of Port C (MSB-LSB). Port C bit assignments are as follows:

PC7	Input	'P' pulse
PC6	Input	'A' pulse
PC5	Output	Mux 'A'
PC4	Output	Mux 'B'
PC3	Output	Mux 'C'
PC2	Reserved	
PC1	Output	Drive Enable
PC0	Output	Drive 'A0'

The normal binary pattern for port C would be: %00011110. Injecting a voltage into TP1 on CB572 should cause bit 6 to go high ('A' pulse). Injecting a voltage into TP2 on CB572 should cause bit 7 to go high ('P' pulse). See diagnostics 1 through 4.

Diagnostic 8: Turn on Low Speed Start Relay

The 'Low Speed Start' relay is turned on (CB513-K1).

Diagnostic 9: Turn on Low Speed Run Relay

The 'Low Speed Run' relay is turned on (CB513-K3).

Diagnostic 10: Turn on High Speed Relay

The 'High Speed Relays' are turned on (CB513 K5 & K6).

Diagnostic 11: Turn on High Speed & Run Relays

The 'High Speed Relays' (CB513 K5 & K6) and the 'Run' relay (CB513 K4) are turned on. If the service jumper is installed, the inverter storage capacitors are charged to about 100 volts DC.

Diagnostic 12: Output Drive 'A0' High

Inverter Drive 'A0' is set high and 'EN' is set low (the inverter should be 1/2 on). U1 & U4 should give positive outputs to respective gates of the IGBT. This allows static checking of the drive signals.

Diagnostic 13: Output Drive 'A0' Low

Inverter Drive 'A0' is set low and 'EN' is set low (the inverter should be 1/2 on). U2 & U3 should give positive outputs to the respective gates of the IGBT. This allows static checking of the drive signals.

Diagnostic 14: Output High Speed Run and Run the Inverter

The 'High Speed Relays' and the 'Run' relay is selected. The inverter is put in the running mode. This allows for checking of the inverter drives and outputs. A square wave should appear at the output of the inverter if the service jumper on the interface board is in the service position. Otherwise, the storage capacitor will be discharged by the inverter action and no voltage will be present at the output of the inverter after a few moments (CB570 pins 5/6 and 9/10).

Diagnostic 15: Output High Speed and Start Relays

The 'High Speed Relays' and the 'Start' relay are turned on. The Inverter storage capacitor is charged to about 500 volts.

Diagnostic 16: Turn on Kaux

The 'Kaux' relay is turned on if the service jumper is in the '**Normal**' position.

The following occurs on the interface board:

1. U3 pins 2 and 7 are set low. This is the 'SE2' signal from the processor board pin 3.
2. U3 pin 1 is set low. This is the Kaux signal from the processor board pin C.

This combination allows the output of U3 (pin 3) to go low and drive K1 (the Kaux relay).

Diagnostic 17: Turn on Interlock

Interlock relay is turned on (simulates coast mode). The following occurs on the interface board:

1. U3 pins 2 and 7 are set low. This is the 'SE2' signal from the processor board pin 3.
2. U3 pin 6 is set low. This is the **IN'TLK** signal from the processor board pin D.
3. U4 pins 3 and 11 are set high. This is the

'SE1' signal from the processor board pin H.

4. U4 trigger pins 2 and 10 are pulsed by the processor board 'Coast Pulses'. This allows the outputs of U4 (pins 13 and 5) to go high which in turn, allows the pull-up resistor R1 to turn on Q1. The relay driver (U3 pin 5) is low so that the interlock relay can be turned on.

Diagnostic 18: Display Low Ram

The particular RAM locations may be called upon when helping to diagnose problems from the factory.

Diagnostic 19: Display Page 2 Ram

The particular RAM locations may be called upon when helping to diagnose problems from the factory.

Exiting Diagnostic Mode:

At any time during diagnostics, press the 'Exit'/'Test' button of the keypad to exit diagnostic mode.

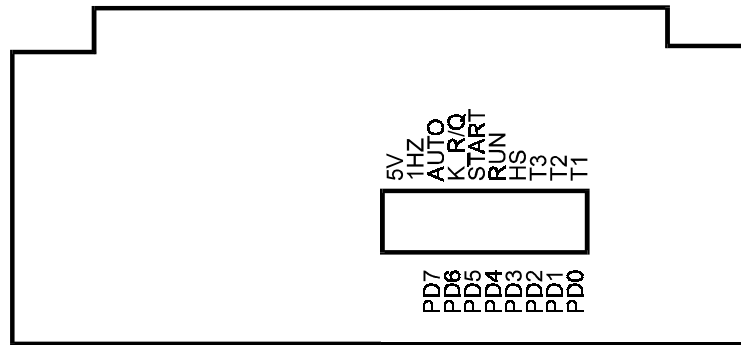

CB574 PROCESSOR BOARD

Port D Bit Assignments (bits 0-7)

Bit 0 is closest to the right hand side of the board looking at the board from the display end.

PD7 = Autotransformer (solid state relay)

PD6 = K_{RQ} Relay (on with 'Q' Stator)

PD5 = Start Relay

PD4 = Run Relay (K2 for low speed, K4 for high speed, Power Relay Board CB513).

PD3 = High Speed Relays (K5 & K6 Power Relay Board)

PD2 = Tube 3

PD1 = Tube 2

PD0 = Tube 1

9. ERRORS (GENERAL)

Note: These error messages are always output to the display. If the failure is pre-rotation or at low speed rotation then the message is output. If the failure is during high speed rotation, then the message is output after the 'AC' brake is applied. With either condition, anode rotation is inhibited. The starter returns to normal operation after one of the following conditions occur:

1. The rotation command has been removed and re-initiated.
2. The tube selection has changed.
3. The 'Test'/'Exit' button on the display panel has been pushed (after the rotation command has been removed).
4. Power has been removed and restored.

9.1 Service Mode (interface):

When the service jumper is in the service position, the current measurement tests are not compared to the 'SETUP' values obtained from the 'test' rotations for low and high speed. This enables the service person to trouble shoot the starter by keeping the starter running.

9.2 Error Messages & Explanation:

9.2.1 P-PULSE NOT LOW, CB572-16

Upon receiving a rotation command, this signal is checked for a low. Failure is most likely due to U1 on CB572. This signal feeds the processor board pin R (PC6). The processor board input can be checked using diagnostic 7.

9.2.2 A-PULSE NOT LOW, CB572-15

Upon receiving a rotation command, this signal is checked for a low. Failure is most likely due to U2 on CB572. This signal feeds the processor board pin P (PC7). The processor board input can be checked using diagnostic 7.

9.2.3 P-SAFETY NOT HIGH, CB573-7

At the moment of changing from accelerate (boost) to run, the safeties are enabled. During 'safeties enabled' this signal is monitored for a continuous high. Most likely cause of failure would be intermittent pulses from U1 on CB572 or failure of U4 on CB573.

9.2.4 A-SAFETY NOT HIGH, CB573-6

At the moment of changing from accelerate (boost) to run, the safeties are enabled. During 'safeties enabled' this signal is monitored for a continuous high. Most likely cause of failure would be intermittent pulses from U2 on CB572 or failure of U4 on CB573.

9.2.5 'P' MEASUREMENT NOT LOW

Upon receiving a rotation command, this signal is checked to verify proper operation of the measurement circuits (current should not be flowing).

9.2.6 'A' MEASUREMENT NOT LOW

Upon receiving a rotation command, this signal is checked to verify proper operation of the measurement circuits (current should not be flowing).

9.2.7 P-SAFETY NOT LOW, CB573-7

During 'Run' the safeties are enabled and this signal is monitored for a continuous low (current is stable). The most likely cause of this error would be from intermittent current or intermittent pulses from U1 on CB572.

Note: Some housings from North American Imaging exhibit very low 'P' Current in high speed. R1 on CB572 needs to be paralleled with a 4.7k to 5.6k resistor to increase current gain. Repeat Current measurements after change. Also refer to section 7.1.

9.2.8 A-SAFETY NOT LOW, CB573-6

During 'Run' the safeties are enabled and this signal is monitored for a continuous low (current is stable). The most likely cause of this error would be from intermittent current or intermittent pulses from U2 on CB572.

9.2.9 CURRENT LOW, 'P' (MAIN)

During rotation, the measured current is compared to the measured values from 'SETUP'. If the measured amount is less than the minimum value from the table, then this error is generated. This error is most likely caused by:

1. The stator being incorrectly wired to the starter (new installation or tube replacement).
2. By intermittent current flowing through the stator (loose stator connections or faulty relay contacts).
3. In high speed run, blown fuse F4 (the storage capacitor discharges to a low value during run).

9.2.10 CURRENT HIGH, 'P' (MAIN)

During rotation, the measured current is compared to the adjusted measured values from 'SETUP'. If the measured amount is more than the maximum value from the table, then this error is generated. This error is most likely caused by:

1. At a new installation, the stator being incorrectly wired to the starter.
2. Grounding or shorting of the stator wires.
3. If the 'Test-Measurement' was performed with a hot stator, then the maximum measured current could exceed the expected maximum value. Repeat the setup procedure to reestablish minimum and maximum values.

9.2.11 CURRENT LOW, 'A' (SHIFTED)

During rotation, the measured current is compared to the measured values from 'SETUP'. If the measured amount is less than the minimum value from the table, then this error is generated. This error is most likely caused by:

1. The stator being incorrectly wired to the starter (new installation or tube replacement).
2. By intermittent current flowing through the stator (loose stator connections or faulty relay contacts).
3. In high speed run, blown fuse F4 (the storage capacitor discharges to a low value during run).

9.2.12 CURRENT HIGH, 'A' (SHIFTED)

During rotation, the measured current is compared to the measured values from 'SETUP'. If the measured amount is more than the maximum value from the table, this error is generated. This error is most likely caused by:

1. At a new installation, the stator being incorrectly wired to the starter.
2. Grounding or shorting of the stator wires.
3. If the 'Test-Measurement' was performed with a hot stator, then the maximum measured current could exceed the expected maximum value. Repeat the setup procedure to reestablish minimum and maximum values.

9.2.13 NO CURRENT, 'A' (SHIFTED)

During acceleration, if a very low value is returned from the measurement circuit, then the 'A' connection is assumed to be open.

9.2.14 NO CURRENT, 'P' (MAIN)

During acceleration, if a very low value is returned from the measurement circuit, then the 'P' connection is assumed to be open.

9.2.15 NO CURRENT DETECTED

During 'Acceleration' or 'Run', if a very low value is returned from the measurement circuits (both 'A' and 'P'), then check for the following:

1. The 'C' or 'Common' connection is open to the stator.
2. No stator is connected.

During Low Speed Acceleration

1. Blown fuse F3 (Autotransformer).
2. Start relay K1 (CB513) not pulling in.
3. Solid State Relay (1SS1) not turning on.

During Low Speed Run

1. Blown fuse F5 (Run) or F3 (autotransformer).
2. Run relay K2 not pulling in or defective contacts.

During High Speed Acceleration:

1. The inverter malfunctioning (dead or half waving).
2. Solid State Relay (1SS1) not turning on.

9.2.16 COAST TIME OUT, ERROR

Coast time exceeded the maximum allowable time programmed in 'SETUP'.

9.2.17 Inverter ERROR, Low Current D=0

Drive select is low (PC0=0), less than minimum current was measured after turning on the drive for the maximum of 3.2 milliseconds. This error may occur with fuse F3 blown. Low power to the inverter will result in low current during start

9.2.18 Inverter ERROR, No Current D=0

Drive select is low (PC0=0), no current was measured after turning on the drive for the maximum of 3.2 milliseconds. This error should only occur when the inverter fails to drive.

9.2.19 Inverter ERROR, Low Current D=1

Drive select is high (PC0=1), less than minimum current was measured after turning on the drive for the maximum of 3.2 milliseconds. This error may occur with fuse F3 blown. Low power to the inverter will result in low current during start

9.2.20 Inverter ERROR, No Current D=1

Drive select is high (PC0=1), no current was measured after turning on the drive for the maximum of 3.2 milliseconds. This error should only occur when the inverter fails to drive.

9.2.21 CPU Math Error

In the power up self test, a math test is performed on the CPU. If the math test fails, this message is displayed and requires replacement of the processor board.

9.3 RESET During Operation

HARDWARE RESET: This reset is generally caused by the arcing of relay contacts during a start, run or brake sequence. This is most likely to occur in the event that the solid state relay is shorted or defective in some way.

The unit will act like it was just turned on and all of the relays will be cycled.

9.4 EEPROM ERRORS

Upon tube selection, two separate tests of the values stored in the EEPROM are done. A checksum and a zero byte check are performed to ensure the integrity of the data stored from the 'SETUP' procedure. If either of the following two messages occurs, then the EEPROM has either lost data or the data has somehow been corrupted.

1. EEPROM CHECKSUM FAILURE
2. EEPROM 0 CHECK ERROR

In order to reestablish the data, proceed with the 'SETUP procedure' of the tube which has the EEPROM error. If the EEPROM still has an error message after following the 'SETUP' procedure, the EEPROM is likely defective and will have to be replaced. All values are programmed into the EEPROM at the 'Exit Step' of 'SETUP'.

Note: If the EEPROM is corrupt, hold the 'Setup' button upon turning the unit on. This will enable you to immediately enter into the setup mode bypassing the EEPROM testing.

If the EEPROM is defective, replace the processor board.

To restore the EEPROM to the factory default values, hold in the 'Value-' and the 'Step+' keys while turning on the power. Release the keys while the 'EEPROM->Default' message is being displayed.

9.5 Web Site, additional information

Visit HMS Electronics on the Web at <http://www.hms-electronics.com> to get the latest information on:

1. Software updates
2. Software bug fixes (with descriptions).
3. New or improved error descriptions.
4. Additional failure and trouble shooting information.

10. TROUBLE SHOOTING (BOARDS)

The **Serv-Norm** (Service-Normal) jumper is provided on the interface board for trouble shooting. In the service position, the software disregards the current measurement circuits for X-ray interlock. This will allow the starter to continue from accelerate (boost) to run in order to trouble shoot the measurement and interlock circuits. The interlock is only enabled if the 'Setup' test rotation is being performed. Otherwise, the interlock is disabled to prevent closure with improper currents to the stator.

10.1 Inverter/Driver (CB570):

Each of the four power supplies should be equally warm. In the event that the fuse is blown, it is likely that the IGBT pack is defective and caused destruction of one or more power supplies and drivers. Replace the board if this is the case.

10.1.1 Standby gate voltage

Each drive circuit should be checked to verify that -15 volts is being applied to the gate of each IGBT while in standby.

10.1.2 Gate resistance

Remove the driver integrated circuits and measure the gate resistance. The gate should show open circuit (very high resistance) with an ohmmeter.

10.1.3 Device resistance

Typically, the devices should measure open (very high resistance) from emitter to collector.

Using an Ohmmeter, measure the resistance of the four power IGBT's (Insulated Gate Bipolar Transistors). They should all be similar in resistance checks. If any IGBT checks shorted, replace the IGBT assembly. It is likely that a defective IGBT will take out the drive circuit (including the power supply). As it is near impossible to replace the IGBT assembly, a replacement board should be ordered.

Note: The IGBT's have reverse diode connections and you should be able to determine the diode form emitter to collector for each device.

10.1.4 Inverter Diagnostics:

Use diagnostics 12 through 14 to test and drive the inverter.

10.1.5 Repeat inverter failures:

1. Check that there is no possibility of the stator wires shorting to each other or to ground as one single arc will instantly destroy the inverter.

2. Check the snubber network on the mother board for an open 15 Ohm 5 watt resistor or open .68 microfarad capacitor.

10.2 Power Relay Board (CB513)

The relays are used to pick up the power from the autotransformer and switch capacitor values for high speed. Each of the relays on the Power Relay board can be operated using the various diagnostics. Use diagnostics 8 through 11 to operate each of the relay conditions.

Note: With the service jumper on the interface board in the normal position, the autotransformer is left off. In the service position, the autotransformer is left on.

10.3 Tube Select & Current Board (CB572)

10.3.1 'A' Current Measurement

Use diagnostics 1 and 2 to determine proper operation of the 'A' measurement circuit. There should be no effect on the 'A' measurement when injecting a voltage into the 'P' measurement circuit.

Mux Addresses:

Low Gain = 1 (001)

A (11) = 1

B (10) = 0

C (9) = 0

High Gain = 7 (111)

A (11) = 1

B (10) = 1

C (9) = 1

10.3.2 'P' Current Measurement

Use diagnostics 3 and 4 to determine proper operation of the 'P' measurement circuit. There should be no effect on the 'P' measurement when injecting a voltage into the 'A' measurement circuit.

Mux Address:

Low Gain = 0 (000)

A (11) = 0

B (10) = 0

C (9) = 0

High Gain = 6 (110)

A (11) = 0

B (10) = 1

C (9) = 1

10.4 Interface & Power Supply (CB573)

10.4.1 Low Voltage Power supplies

Check the regulated +24 volt, +5 volt and -5 volt supplies and verify them as being OK (+-.1 volts). Typically, each supply should have

about 4 volts or more of head room for proper operation. I.E. the unregulated 24 volt supply should measure a minimum of 28 volts.

Note: If any ripple from the +5 volt supply gets through to the processor board, it would be likely that the processor board will be continuously resetting. The watchdog chip (U1 on the processor board) causes reset if the 5 volts supply falls below 4.65 volts.

10.4.2 Interface Indicators & Levels

Using the Light Bar as an indicator, verify that the corresponding light illuminates with the appropriate input optocoupler being activated. The outputs of the optocouplers should meet standard voltage levels for TTL. I.E. A low of less than .8 volts and a high of more than 2.0 volts.











Note: The optocouplers are open collector output devices. A header is provided just below the light bar so that a standard .1 inch shorting plug can be used to parallel the outputs of the optocouplers.

10.4.3 100/120 Hz Line Crossing Signal

In the event that the CPU seems dead, verify the presence of the 100/120 Hz signals from U5 on CB573. There should be 100 Hz for 50 cycle line or 120 Hz pulses for 60 cycle line. All output timing (to the relays from the processor board) is derived from the line crossing signals.

10.5 Microprocessor Board (CB574)

The following diagram for the light bar is given for your convenience.

	10 +5 Volts
	9 1 Hz signal
	8 Autotransformer On
	7 KR/Q Relay on
	6 Start (K1/K3 CB513)
	5 Run (K2/K4 CB513)
	4 High Speed Relay Selection
	3 Tube 3 Relay (K3-CB572)
	2 Tube 2 Relay (K2-CB572)
	1 Tube 1 Relay (K1-CB572)

CB574 Light Bar Diagram

Verify that the "1Hz" status LED on the processor board flashes at 1 second intervals. If it does not, check for the presence of the 100/120 Hz line crossing signals from CB573 (interface board). If the line crossing signals are present and the 1 Hz LED of the light bar is not flashing then the CPU is likely not running.

The microprocessor board has its own power up reset and watchdog circuit. Verify that power-up reset is high (U1 pin 6). If the reset remains low replace the reset circuit U1. If reset performs properly, check for the 50/60 Hz pulses to U10 (CA1 pin 40). The reset and watchdog chip "DS1232" will maintain a low at the reset output if the 5 Volt supply falls below 4.65 Volts.

In the event of a microprocessor board malfunction, the board should be replaced.

11. THEORY OF OPERATION **(OVERVIEW)**

There are two AC power supplies. A 50/60 Hz line supply and a 180 Hz inverter supply. If low speed is commanded, the 50/60 Hz source will supply 220 Volts AC for start and 60 Volts AC for run. For high speed operation, the 180 Hz inverter chops 440/500 Volts DC (start) and 100 Volts DC (run) into 180 Hz, for "R" stator. For "Q" stator 350 Volts DC (start) and 80 Volts DC (run).

*420VAC if tap 12, 370VAC if tap 11 see 'Start voltage selection'.

The start and run voltages are directed into the phase shift capacitor and current sensing circuits. By output relay selection, either of three tubes may be selected.

Brake from high speed is accomplished in two stages. First 220 Volts AC 50/60 Hz is applied. If DC brake is programmed, then DC is applied by applying the inverter run voltage but in DC mode (inverter not running). The control of all functions is achieved by relays driven by a microprocessor. The microprocessor responds to commands from the generator. With its memory and the input data, all functions are monitored and current operating status is indicated on LED'S.

Refer to the over all schematic. Mother board terminals are identified by brackets [] in this section of the manual.

In low speed operation, 220 Volts AC or 60 Volts AC is taken directly from transformer 1T1 (220VAC) [B], passed through relay K5 to [PS6] and [PS25] terminals. [PS6] is the principal winding source. [PSC] is connected to 1C1 and 1C2 which are the phase shift capacitors. Terminal [PSC] is the auxiliary winding source.

The AC passes from [PS6] and [PSC] directly to whichever tube is selected.

For high speed operation, either start

(420 or 380 Volts AC) or run voltage (72 Volts AC) is directed to 1CR1 through two surge limiting resistors 1R1 and 1R2. For a 'Q' stator, 300 Volts AC or 55 Volts AC is selected via the K_{RQ} relay. The DC output of the rectifier and storage capacitors (1C3 and 1C4) is connected to terminals [V+] and [V-] and is the DC supply for the inverter.

On the Inverter Driver Board (CB570), the two sets of optocouplers are driven by the microprocessor port C bits 0 and 1. Port C bit 1 enables the decoder chip U1 to drive the IGBT optocouplers. Port C bit 0 toggles the output of the decoder and therefore the drive sequence. This design allow only the correct half of the inverter to be turned on at a time. The timing consists of 5.68 millisecond intervals and is set by internal programing (180 Hz). These signals are coupled through the optocouplers to the bases of the four IGBT's. The optocouplers have isolated power supplies as required for operating the inverter transistors.

Terminals 5/6 and 10/11 of CB570 are the output of the inverter and the source of the 180Hz AC square wave. This 180Hz is applied via K5 relay contacts (now energized) to [PS6] and through 1C2 to [PSC]. The voltage is passed to the selected stator via the tube selection relays on the tube select board (CB572).

Input data, from the generator, is isolated by optocouplers to protect the microprocessor from external noise. The conditions of the inputs is indicated by the light bar on the interface board. The data is passed through input ports to the microprocessor and software routine. Output ports control Driver transistors and operating status LED's. The solid state relay 1SS1 is opened each time any power relay is actuated. This removes incoming power momentarily and prevents contact arcing of the contacts as the relays are activated.

CURRENT DETECTION

During Acceleration of the anode, the current amplitude is measured in both the 'Principle' or 'Main' winding and the 'Auxiliary' or

'Phase' winding of the stator. This is compared to the 'TEST' values obtained from the 'SETUP' of the tube. If the measured current does not fall within the measured 'TEST' value, acceleration is stopped and an appropriate error message is generated. The same measurements are checked during 'Run' mode of the tube.

If the run values of the tube do not fall within the measured values. Appropriate messages are displayed.

DC BRAKE

DC brake is achieved by applying High Speed run signals to appropriate relays, and the microprocessor turns on 1/2 of the inverter during the brake period. This applies about 60 Volts DC to the stator "Principal" or "Main" winding.

12. THEORY OF OPERATION (BOARDS)

12.1 Inverter CB570

CB570 contains all of the inverter circuitry including the isolated power supplies, optocoupler drivers and IGBT transistors.

The optocouplers are IGBT drivers. The small power supplies (PS1-PS4) supply the isolated +-15 Volts DC necessary for proper gate drive parameters. Should one of the power supplies or optocouplers short, a fuse is provided for the protection of the +24 Volt power supply. LED1 is provided for easy visual indication of a blown fuse.

The PROM chip (U1) is driven by the processor board and drives the optocouplers. The drive sequence is as follows:

The enable pin is set low (enable drive). The toggle pin A0 (drive 1/drive 2 is left as is). After the drive duration has elapsed, the enable pin goes high (disabling drive and the IGBT shuts off), the toggle pin changes state, and the drive pin is re-enabled (goes low).

See diagram below for the drive sequence.

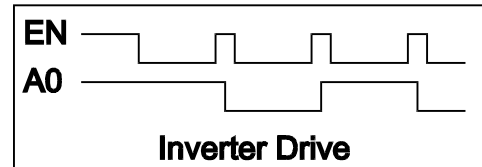

12.2 Power Relay Board CB513

50/60 Hz mode: K1 is pulled in to supply the tube select board with 220 Volts AC for acceleration of the anode. In run, K1 is released K3 is pulled in to provide 60 Volts AC.

180 Hz Mode: K5 & K6 are turned on to select high speed operation (connections are made to the inverter). K2 is pulled in to supply the inverter with Acceleration voltage. K5 & K6 (already on) connect the output of the inverter to the tube select board CB572. After the programmed delay for acceleration, K3 is dropped out and K4 is turn on to supply the inverter with the run voltage. K5 also serves the function of dropping out the extra phase shift capacitance necessary for low speed.

12.3 Tube Select & Current CB572

CB572 has 3 relays to select up to 3 stators. Current from both the Principle and Auxiliary windings are fed back to the processor board. After a rotation command has been received, both current feedback channels are measured to verify that no current feedback is detected. During acceleration, low gain is selected via the MUX U3, and at appropriate times during acceleration, the Principle and Auxiliary current are measured to insure proper current draw from the stator. In Run mode, the MUX (U3) is switched to high gain and the run currents are monitored during run.

Current measurement for both the 'P' and 'A' currents are identical. Only the 'P' circuit will be explained. Current through the 'P' or main winding is coupled through the current transformer T1. The output of the current transformer is amplified by the variable gain amplifier U2A. U2A gain is controlled by the analogue

MUX, U3. For high gain mode, R9 is grounded which reduces the feedback and therefore increases the gain. The output of U2A is passed on the active rectifier circuit consisting of U2B and U2C. The output of the active rectifier circuit (D5 and D6) is coupled to the analogue detector U2D and to the MUX input. The MUX is addressed by the processor board to obtain the analogue value of the 'P' measurement circuit. In accelerate mode, the gain is set low as the current is high. Conversely, in run mode, the gain of the feedback circuit is set high as the current is low. The analogue detection circuit is used to provide pulses to the safety monitor circuit located on the interface board. The pulse output (which should be low in standby) are also monitored by the processor board.

12.4 Interface Board CB573

CB573 has the following functions:

1. All low voltage power supplies (+24, +5 and -5 volts) are complete on the board.
2. The 100/120 Hz line crossing signal is supplied to the processor board via U5.
3. All external inputs are buffered by the optocouplers and passed on to the processor board. The status of the inputs is indicated on the light bar. A convenient header is provided to measure or monitor the outputs of the optocouplers. The top row of pins on the header are connected to the optocoupler outputs, the bottom row of the header is connected to signal ground. Any input can be simulated by inserting a standard .1 inch shorting plug on the header.
4. The interlock relay (K2) is controlled by the processor board and either requires pulses from both the 'P' and 'A' measurement circuits on CB572, or coast pulses from the processor board. During acceleration U3 is enabled from the processor board so that the Kaux relay can be controlled. The one-shot chip U4 is also enabled and the not 'Q' outputs are monitored to insure continuous pulses are coming from CB572 (the not 'Q' outputs should be a continuous high during acceleration or run).

In coast mode, pulses are provide to the

one-shot (U4) by the processor board to enable the turning on of the interlock.

5. The Kaux relay is directly controlled by the processor board.

12.5 Processor Board CB574

The processor board controls all functions of the starter. During 'SETUP', various values set by the operator are stored in the EEPROM as each step is completed. During 'Test' of Low Speed and High Speed, the values of the 'P' or 'Main Current' and 'A' or 'Shifted Current' is measured and stored in memory for both accelerate and run conditions. The values of these measurements are transferred to the EEPROM at the end of the 'SETUP' programming. During operation, these values are used as the base for determining correct operation of the starter and connections. In the event that the display malfunctions, the display can be removed to enable the processor to continue to function.

13.0 PARTS LISTS (MAIN)

13.1 HS3-R MASTER PARTS LIST

REFERENCE	DESCRIPT	HS1R Master Parts List PART_N
CB4X5EXT	BOARD ASSEMBLY	CB4X5EXT
CB513	Power Relay Board	CB513-5B
CB570	Inverter/Driver	CB570-1A
CB572	Tube Select & Current	CB572-1A
CB573	Interface, Low Voltage	CB573LV
CB574	Processor Board	CB574-1A
CB575	Mother Board	CB575-1
HS3-1C1	AC CAP 25MFD @ 370	97F9006
HS3-1C2	AC CAP 6MFD @ 660	26F6623FA
HS3-1C3	CAPACITOR, POWER	CGS432T250V3C3PH
HS3-1C4	CAPACITOR, POWER	CGS432T250V3C3PH
HS3-1CR1	35 AMP 1.2KV BRIDGE RECT.	35MB120A
HS3-1F1	FUSE, SLO-BLO	MDL 2/10
HS3-1F2	FUSE, SLO-BLO	MDL 2/10
HS3-1F3	FUSE, SLO-BLO	MDA 8
HS3-1F4	FUSE, SLO-BLO	MDA 7
HS3-1F5	FUSE, SLO-BLO	MDA 7
HS3-1FH1	FUSE HOLDER, 1 1/4"	HKP
HS3-1FH2	FUSE HOLDER, 1 1/4"	HKP
HS3-1FH3	FUSE HOLDER, 1 1/4"	HKP
HS3-1FH4	FUSE HOLDER, 1 1/4"	HKP
HS3-1FH5	FUSE HOLDER, 1 1/4"	HKP
HS3-1R1	RESISTOR, 50W	RH50-.2 OHM 1%
HS3-1R2	RESISTOR, 50W	RH50-.2 OHM 1%
HS3-1R3	56K RESISTOR ASSY	46-2-1
HS3-1R4	56K RESISTOR ASSY	46-2-1
HS3-1R5	30K RESISTOR ASSY	46-3-1
HS3-1R6	30K RESISTOR ASSY	46-3-1
HS3-1SS1	55 AMP, 240V SS RELAY	SSR600240D55
HS3-1T1	TRANSFORMER, AUTO	6331A
HS3-1T2	TRANSFORMER, LOW VOLTAGE	6165C
HS3-2RHS	HEAT SINK	42-92-1
HS3-BAR-SET	HS3-BAR SET	42-95-2
HS3-CB-250	CIRCUIT BREAKER BRACKET	42-93-1
HS3-CB1	CIRCUIT BREAKER 20 AMP	UPL11-30188-1-V
HS3-CG	CARD GUIDES (16 EA.)	3.5 INCH GUIDE (16 EA.)
HS3-CONN. KIT	HS3 INSTALL CONNECTOR KIT	46-5-1
HS3-CP	PLATE, CP	42-90-1
HS3-LH	PLATE, LH	42-88-1
HS3-RH	PLATE, RH	42-89-1
MISC 1	WIRE	HS3-WIRE
MISC 2	HARDWARE	HS3-HARDWARE

13.3 HS3-RQ MASTER PARTS LIST

HS3-RQ Master Parts List

REFERENCE	DESCRIPT	PART_N
CB4X5EXT	Extender Baord	CB4X5EXT
CB513	Power Relay Board	CB513-5B
CB570	Inverter/Driver	CB570-1A
CB572	Tube Select & Current	CB572-1A
CB573LV	Interface, Low Voltage	CB573LV
CB574	Processor Board	CB574-1A
CB575	Mother Board	CB575-1
HS3-1C1	AC CAP 25MFD @ 370	97F9006
HS3-1C1A	AC CAP 20MFD @ 440	97F9039
HS3-1C2	AC CAP 6MFD @ 660	26F6623FA
HS3-1C2A	AC CAP 15MFD @ 440	97F9037
HS3-1C3	CAPACITOR, POWER	CGS432T250V3C3PH
HS3-1C4	CAPACITOR, POWER	CGS432T250V3C3PH
HS3-1C5	CAPACITOR, (250 LINE)	539-158X104
HS3-1CR1	35 AMP 1.2KV BRIDGE RECT.	35MB120A
HS3-1F1	FUSE, SLO-BLO	MDL 2/10
HS3-1F2	FUSE, SLO-BLO	MDL 2/10
HS3-1F3	FUSE, SLO-BLO	MDA 8
HS3-1F4	FUSE, SLO-BLO	MDA 7
HS3-1F5	FUSE, SLO-BLO	MDA 7
HS3-1FH1	FUSE HOLDER, 1 1/4"	HKP
HS3-1FH2	FUSE HOLDER, 1 1/4"	HKP
HS3-1FH3	FUSE HOLDER, 1 1/4"	HKP
HS3-1FH4	FUSE HOLDER, 1 1/4"	HKP
HS3-1FH5	FUSE HOLDER, 1 1/4"	HKP
HS3-1KRQ	RELAY	HG4-DC24V
HS3-1KRQ-S	SOCKET, RELAY	HG4-SS
HS3-1R1	RESISTOR, 50W	RH50-.2 OHM 1%
HS3-1R2	RESISTOR, 50W	RH50-.2 OHM 1%
HS3-1R3	56K RESISTOR ASSY	46-2-1
HS3-1R4	56K RESISTOR ASSY	46-2-1
HS3-1R5	56K RESISTOR ASSY	46-2-1
HS3-1R6	56K RESISTOR ASSY	46-2-1
HS3-1R7	30K RESISTOR ASSY	46-3-1
HS3-1R8	30K RESISTOR ASSY	46-3-1
HS3-1SS1	55 AMP, 240V SS RELAY	SSR600240D55
HS3-1T1	TRANSFORMER, AUTO	6331A
HS3-1T2	TRANSFORMER, LOW VOLTAGE	6165C
HS3-2RHS	HEAT SINK	42-92-1
HS3-BAR-SET	HS3-BAR SET	42-95-2
HS3-BKT-1	PLATE, HGR RELAY MTG.	42-18-2
HS3-CB-250	CIRCUIT BREAKER BRACKET	42-93-1

Please Order Circuit Boards without the suffix. eg. order CB513 not CB513-1A

HS3-CB1	CIRCUIT BREAKER 20 AMP	UPL11-30188-1-V
HS3-CG	CARD GUIDES (16 EA.)	3.5 INCH GUIDE (16 EA.)
HS3-CONN. KIT	HS3 INSTALL CONNECTOR KIT	46-5-1
HS3-CP	PLATE, CP	42-90-1
HS3-LH	PLATE, LH	42-88-1
HS3-RH	PLATE, RH	42-89-1
MISC 1	WIRE	HS3RQ-WIRE
MISC 2	HARDWARE	HS3RQ-HARDWARE

Board parts lists are not included as all the board components are identified on the schematics. Boards should be ordered for replacement when failure occurs.

14. SCHEMATICS

Schematics for the boards, interface and main schematic follow this page.